

技术参数

显示器尺寸	承重范围(kg)	升降(mm)	俯仰角	左右摆动	旋转	VESA	包装箱尺寸 (mm)	净重(kg)	毛重(kg)	装夹范围 (mm)
≤30"	≤12		-10° ~ +90°	180° /360°	±90°	75*75 100*100	内/外: 3/1			30-65

产品外形尺寸

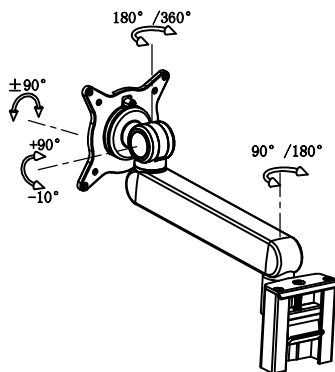
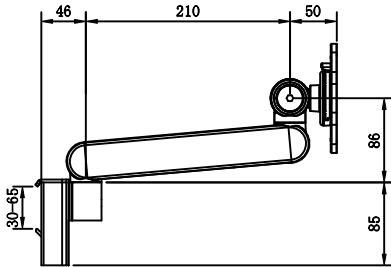

产品部件清单

序号	部件示意图	型号		部件数量
		TM104-S		
A		✓		1
B		✓		1
C		✓		1

产品配件清单

序号	配件示意图	配件规格	配件数量
a		M4x16	4
b		M6	1
c		M4	1

屏风式安装方式

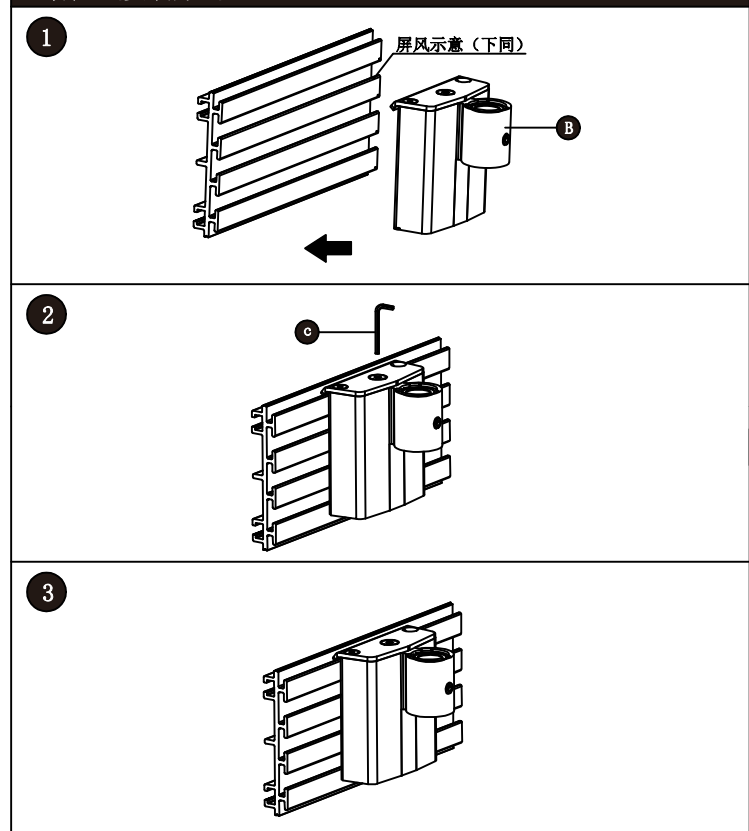

安装步骤

1

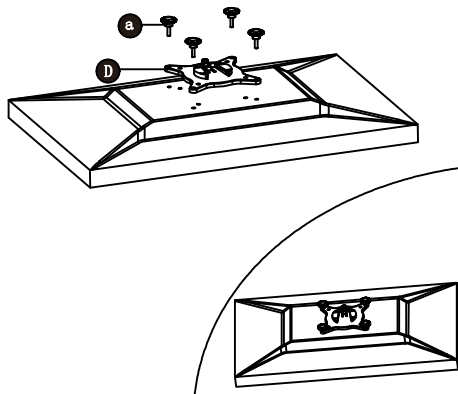

2

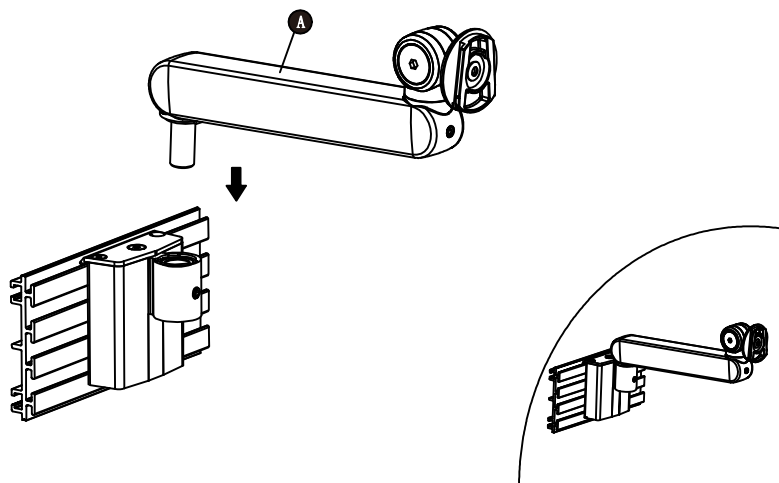

3

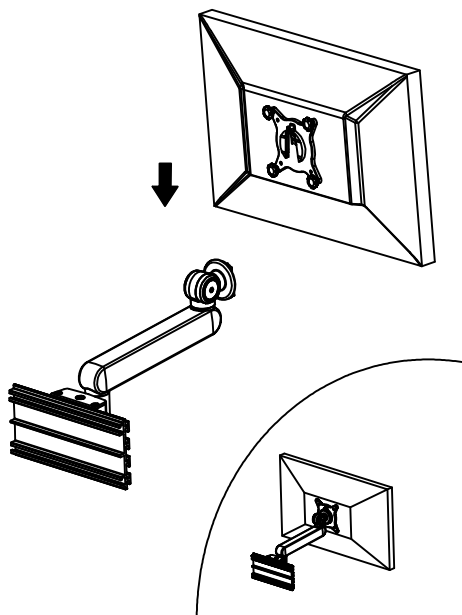

4

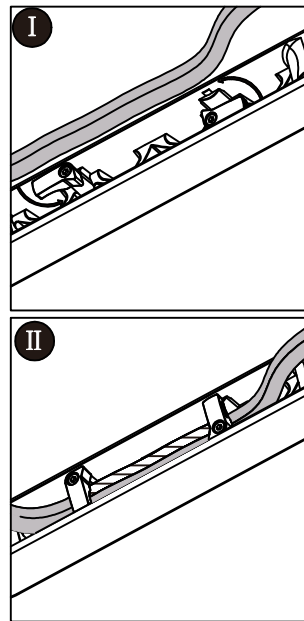
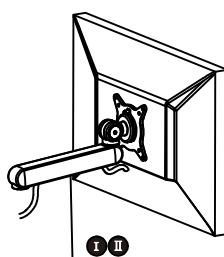

旋转限位

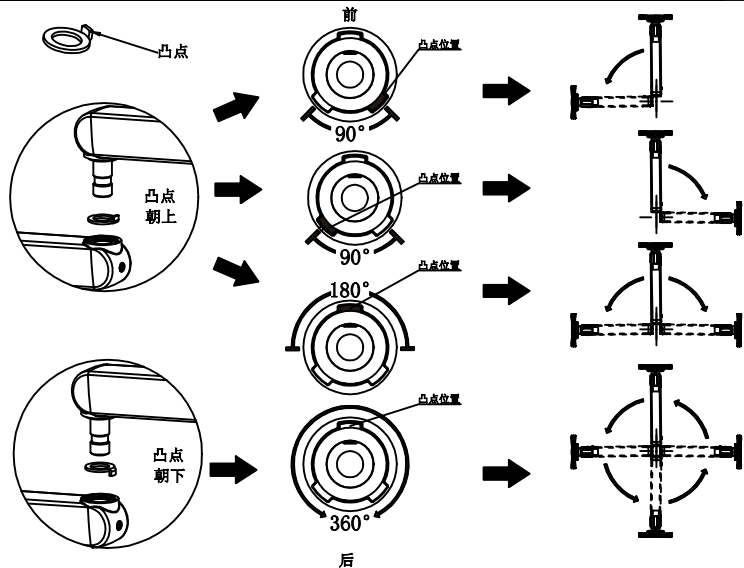

锁定调节步骤

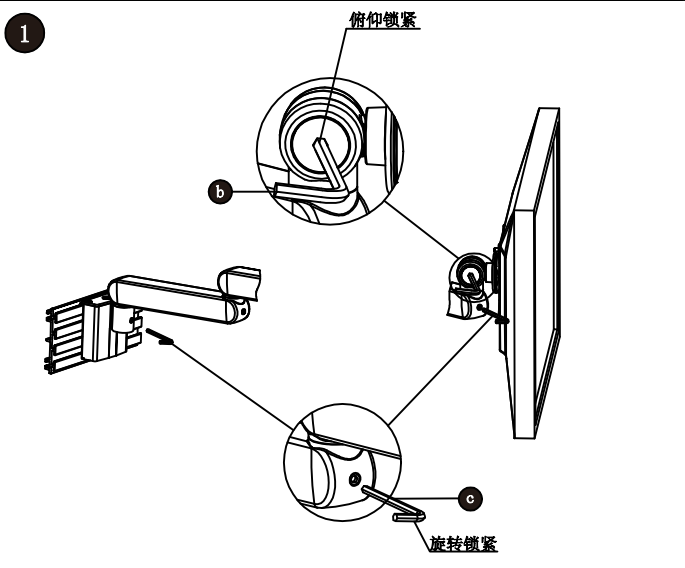

2

