











技术参数

										穿孔安装
显示器尺寸	承重范围 (kg)	升降 (mm)	俯仰角	左右摆动	旋转	VESA	包装箱尺寸 (mm)	净重 (kg)	毛重 (kg)	孔距 (mm)
≤32"	12	495	±20°	±80°	±90°	75*75 100*100	865*465*116	7	8.5	171.5



使用说明

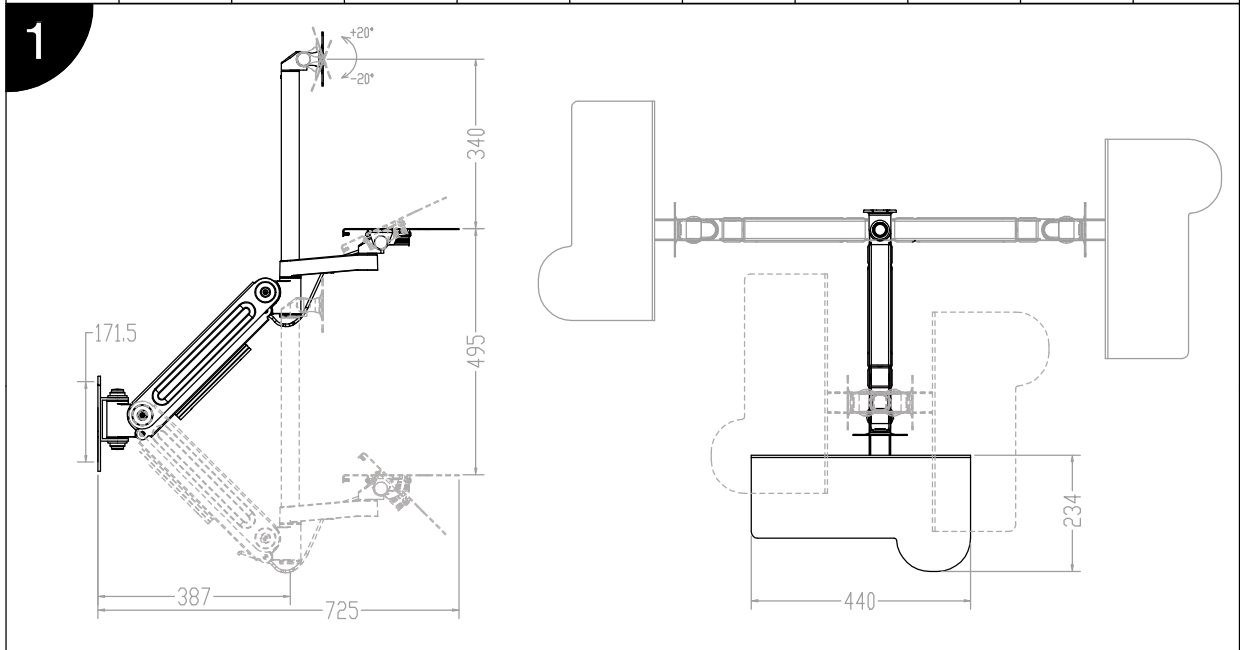