

产品使用说明书

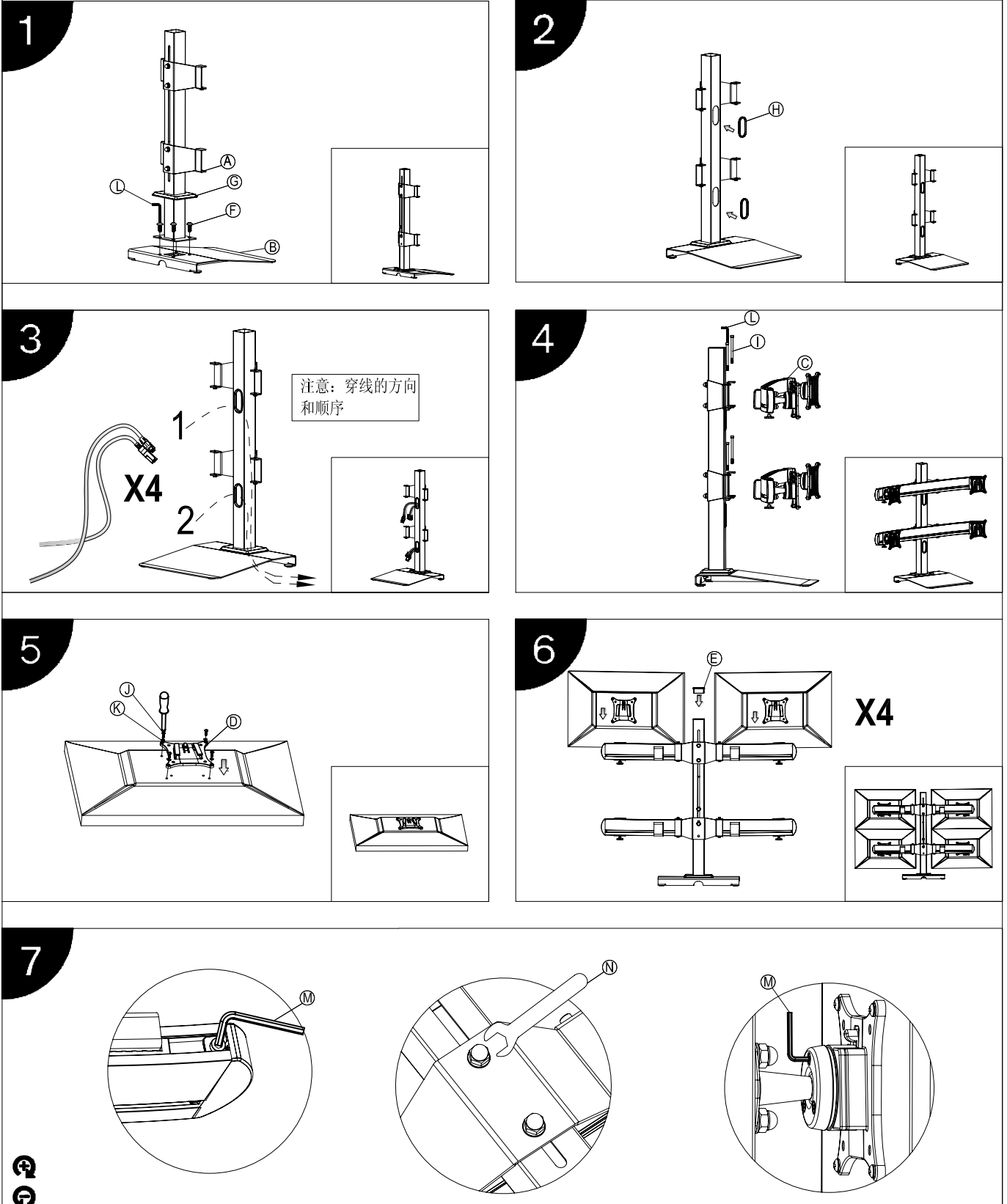









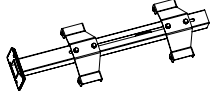

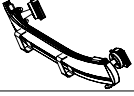

产品型号: BL401

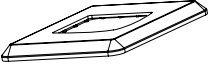
安装步骤

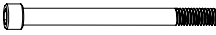

产品使用说明书

产品型号: BL401

标准配件			
序号	示图	规格	数量
A			1
B			1
C			2
D			4
E			1
F		M8*20	4
G			1
H			2
I		M6*80	4
J		M4*12	16
K		M4	16
L		M5	1
M		M3	1
N		M8	1